



grohe.com

*Pure Freude
an Wasser*



PERFECT **MATCH**

INTRODUCING GROHE CERAMICS





CONTENTS

LEARN MORE ABOUT THE WORLD OF GROHE CERAMICS	04
KEY TECHNOLOGIES	14
BAU CERAMIC	26
INSPIRATION	28
COLLECTION	34
EURO CERAMIC	38
INSPIRATION	40
COLLECTION	46
CUBE CERAMIC	50
INSPIRATION	52
COLLECTION	58
LINE OVERVIEW	62
MATCHING FAUCET LINES	64
RECOMMENDATIONS	66
TECHNICAL DRAWINGS	68
GROHE BRAND	82





GROHE NOW ENTERS
THE WORLD OF CERAMICS
**CREATING PERFECTLY
COORDINATED BATHROOMS**

“We believe that a complete bathroom solution is the key to customer satisfaction.”

MICHAEL RAUTERKUS, GROHE AG CEO



GROHE CERAMICS: MADE TO MATCH IN FORM AND FUNCTION

Finding a perfect match isn't easy. That's also true for the bathroom. Because our ceramics come with a selection of recommended combinations that fit our faucets, showers and sanitary systems they complement one other in both design and technology: the overwhelming variety of options is distilled into one simple choice. Save yourself the trial and error and make only one easy choice: for a perfect match.

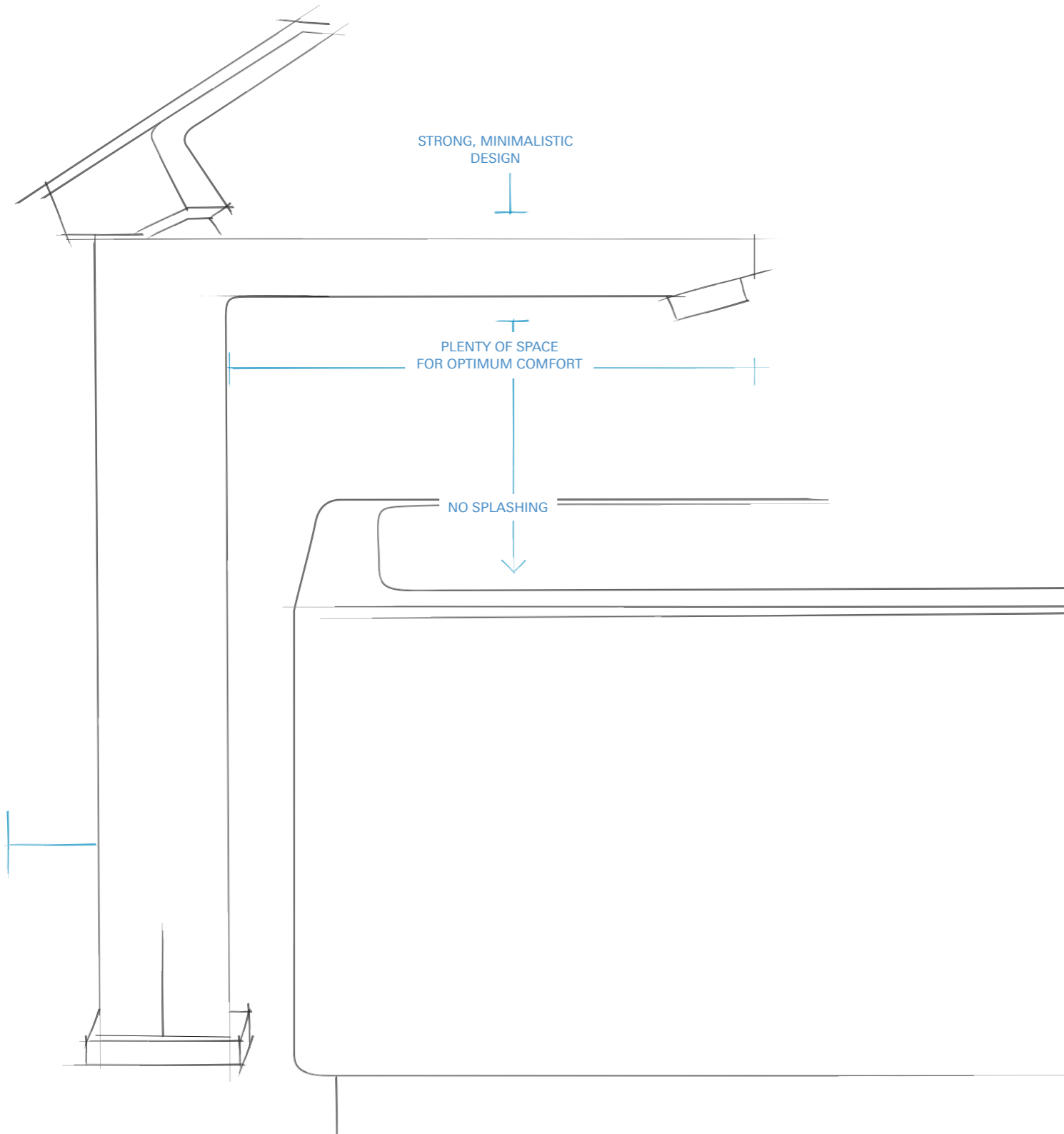

OUR ASPIRATION IS PERFECTION IN EVERY DETAIL **THAT'S WHY WE CREATED PERFECT MATCHES**

With GROHE Ceramics there is no need to rely on guesswork. Our dedicated design team looked at each individual product to determine which faucet and basin shapes look best together, guaranteeing you a seamless, complete design aesthetic. In addition, we physically tested our products against three criteria to make sure every suggested combination offers you a perfect match:

- Easy installation
- No splashing during handwashing
- Plenty of space for optimum comfort

“We wanted to establish a natural relationship between two objects.”

MICHAEL SEUM, GROHE VICE PRESIDENT DESIGN



**WE ARE CONVINCED THAT
TWO ELEMENTS CAN
ACHIEVE PERFECT BALANCE**
LET OUR IDEAL COMBINATIONS
SURROUND YOU WITH SERENITY

“Only a perfect match can give
design the presence it deserves.”

MICHAEL SEUM, GROHE VICE PRESIDENT DESIGN



AS PART OF THE STRONG LIXIL GROUP THIS VISION COMES TRUE **BY COMBINING OUR KNOWLEDGE IN DESIGN AND TECHNOLOGY**

Together we're stronger. We combined our GROHE expertise as a world leader in sanitary fittings with the unique technology and insights from LIXIL's other Water Technology brands.

Over fifteen ceramic manufactories belong to the LIXIL group, making it one of the biggest suppliers of sanitary ceramics in the world. This now allows GROHE to offer a complete bathroom solution, featuring innovative products like shower toilets and SmartControl showers, alongside revolutionary technologies such as AquaCeramic. Beautiful, functional and reliable, LIXIL's products and solutions are changing the way people live, all over the world.

"Our affiliation to one of the leading manufacturers of sanitary ceramics worldwide makes us very proud."

MICHAEL RAUTERKUS, GROHE AG CEO

PART OF **LIXIL**

FIVE COMPELLING TECHNOLOGIES

You may not see it at first sight – but our ceramics are equipped with the most advanced technology. At GROHE it is our aspiration to make your time in the bathroom as comfortable as possible without any restrictions. Discover our innovative GROHE technologies.

OUR KEY TECHNOLOGIES



 **TRIPLE VORTEX FLUSH**
THE POWER OF THREE: CLEAN AND SILENT



 **AQUACERAMIC**
DOUBLE THE PROTECTION FROM IMPURITIES



 **PROGUARD**
TOO SMOOTH FOR DIRT TO STICK TO



 **HYPERCLEAN**
NO CHANCE FOR BACTERIA TO GROW



 **RIMLESS TECHNOLOGY**
LEAVES BACTERIA NOWHERE TO HIDE

TRIPLE VORTEX

THE POWER OF THREE: CLEAN AND SILENT

Unlike other toilets, GROHE's innovative Triple Vortex flush system creates a powerful but silent vortex of water that swirls to cover and clean the whole of the bowl. Despite its power, this effective system is unlikely to splash and has low water consumption, with a dual flush option that uses just 5l of water and only 3l for a short flush. Instead of one or two water outlets, the Triple Vortex system flushes from three outlets to create a powerful suction that leaves nothing behind.

- So powerful, it leaves nothing behind
- Available for all toilets of Euro Ceramic and Cube Ceramic



TRIPLE VORTEX



RIMLESS TECHNOLOGY LEAVES BACTERIA NOWHERE TO HIDE

With GROHE rimless technology, every surface of your toilet is easy to reach and effortless to keep clean, even in places you can't see. It makes bacteria hiding in corners and crevices under the rim a thing of the past. GROHE rimless technology leaves bacteria nowhere to hide.

- The technology for fast and easy cleaning
- Available for all toilets of all three lines



RIMLESS TECHNOLOGY

UNIQUE COMBINATION FOR EURO CERAMIC AND CUBE CERAMIC



PROGUARD – TOO SMOOTH FOR DIRT TO STICK TO

GROHE ProGuard creates a smooth surface that scale and dirt can't stick to. It uses a layer that creates a floating 'lotus' effect to prevent limescale and attracting further dirt and grime.

With this innovative surface treatment, you benefit from effortless cleaning and a maintaining sparkling, fresh from-the-box finish.

- Keeps your ceramics clean and sparkling white



HYPERCLEAN – NO CHANCE FOR BACTERIA TO GROW

Take confidence that your bathroom is hygienic and clean with GROHE HyperClean, which uses naturally anti-bacterial silver ions to inhibit germs and prevent stains and odour. During the glazing process this exceptionally smooth and hardwearing finish is added which prevents 99.9% of bacteria growth,

meaning your ceramics stay sparklingly clean and germ-free with the minimum of effort. Take peace of mind from this feature, certified by the Society of industrial technology for antimicrobial articles, guaranteed to make your bathroom a safer, cleaner and germ free place for you and your family.

- Its anti-bacterial silver ions prevent 99,9% of bacteria growth



01
PROGUARD

02
HYPERCLEAN



surface without HyperClean



surface with HyperClean

PREMIUM COMBINATION FOR CUBE CERAMIC WC RANGE



AQUACERAMIC – DOUBLE THE PROTECTION FROM IMPURITIES

It creates a smooth surface that impurities can't stick to, meaning the bowl becomes clean after only one flush. This innovative surface treatment works in two ways: first, it uses a smooth, hydrophilic layer to prevent residues sticking to the bowl. And second: its nano-technology prevents limescale latching onto the surface and attracting dirt and grime.

After just one flush, there's no dirt left in the bowl.

The AquaCeramic surface is coated before firing, ensuring that the ceramic surface stays clean for a lifetime. Even scrubbing won't wear it off. Making cleaning effortless and maintaining the sparkling, fresh-from-the-box finish.

— With smooth surface that impurities can't stick to



HYPERCLEAN – NO CHANCE FOR BACTERIA TO GROW

Take confidence that your bathroom is hygienic and clean with GROHE HyperClean, which uses naturally anti-bacterial silver ions to inhibit germs and prevent stains and odour. During the glazing process this exceptionally smooth and hardwearing finish is added which prevents 99.9% of bacteria growth,

meaning your ceramics stay sparklingly clean and germ-free with the minimum of effort. Take peace of mind from this feature, certified by the Society of industrial technology for antimicrobial articles, guaranteed to make your bathroom a safer, cleaner and germ free place for you and your family.

— Its anti-bacterial silver ions prevent 99,9% of bacteria growth

01 AQUACERAMIC



WITH
AQUACERAMIC



WITHOUT
AQUACERAMIC

02 HYPERCLEAN



surface without HyperClean



surface with HyperClean

THREE UNIQUE CERAMIC DESIGN LINES

Create pure unison in your bathroom: with GROHE Ceramics. If you choose one of our perfect matches, you can be sure that you are composing a coherent and perfectly designed style.

Whatever your lifestyle, whatever your taste, you'll find the perfect combination of products within GROHE's three new ceramic ranges. Each has its own distinctive qualities and they make creating a visually unified bathroom simple and fun.



EURO CERAMIC
IN TUNE WITH MY LIFESTYLE



BAU CERAMIC
VERSATILITY FOR A MODERN LIFE



CUBE CERAMIC
A CLEAR STYLE STATEMENT

01

BAU CERAMIC



39 435 000
Seat & cover soft close



39 433 000
Wall hung bidet



39 421 000
Wall hung basin
60 cm

39 426 000
Semi pedestal

39 427 000
Wall hung WC

BAU CERAMIC

VERSATILITY FOR A MODERN LIFE

Every professional project needs a versatile design line that fits harmoniously into each bathroom interior. With its soft and round forms, Bau Ceramic is the perfect choice for the bathroom interiors of hotels, offices and residential housing. Its contemporary style makes it the perfect solution for your project, suiting every taste.

Bau Ceramic is a versatile all-rounder that offers state-of-the-art technology. By making all toilets rimless we made sure users benefit from the highest hygiene standards. This range will most certainly make your project a success.

— All toilets are rimless at no added cost*



RIMLESS TECHNOLOGY

*2PC toilet available in 2018





39 420 000
Wall hung basin
65 cm

39 436 000
Cistern with bottom inlet

39 425 000
Pedestal for
wash basin

39 428 000
Floorstanding WC
close coupled



39 424 000
Handrinse basin, 45 cm



39 423 000
Undercounter basin, 55 cm



39 421 000
Wall hung basin, 60 cm

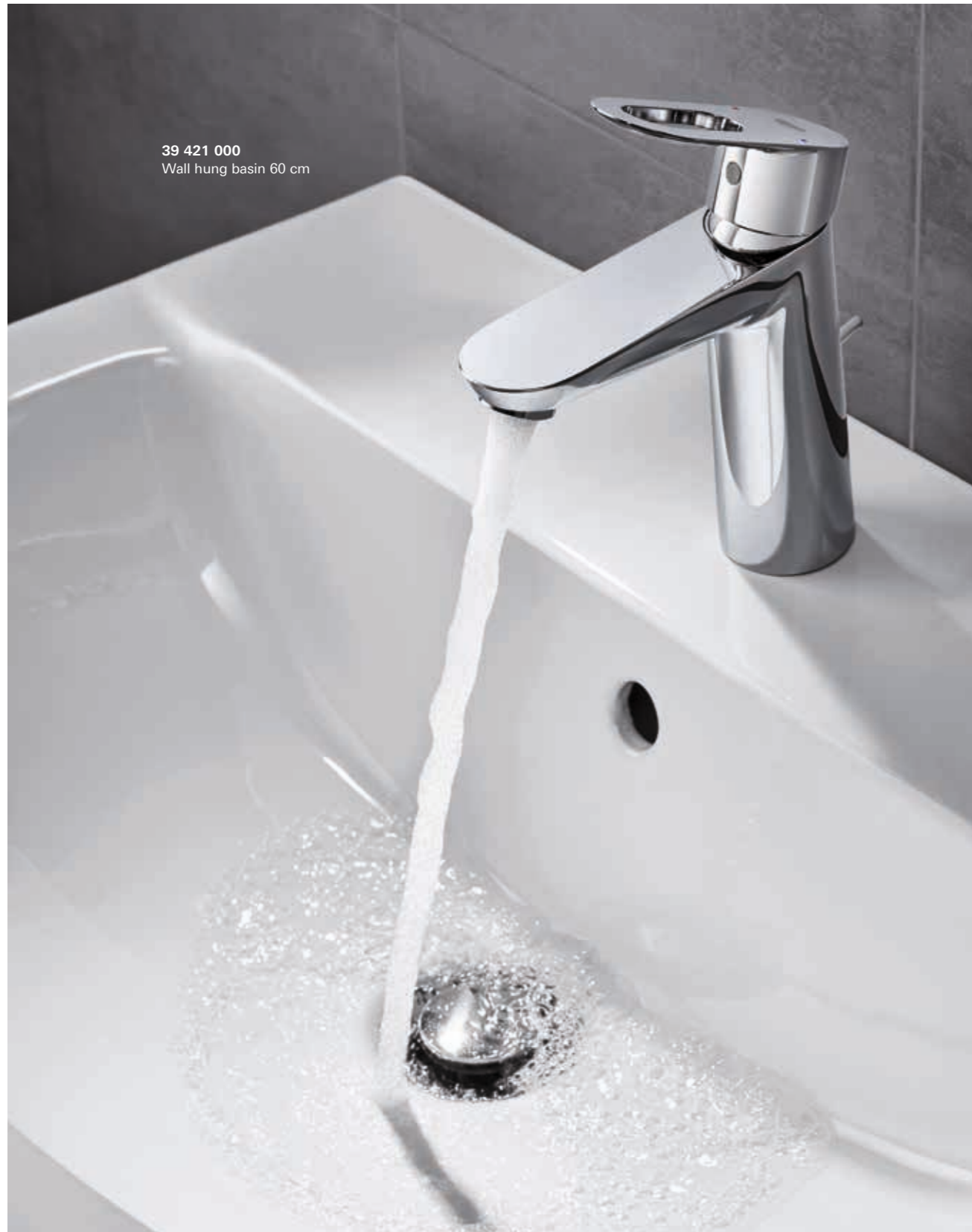

39 421 000
Wall hung basin 60 cm



39 427 000
Wall hung WC

39 433 000
Wall hung bidet

A bathroom that appeals to everyone: its sleek forms make Bau Ceramic the ideal collection for residential and public buildings.

BAU CERAMIC COLLECTION

A clean and modern design can be truly appealing – that's why we gave Bau Ceramic an understated look. This collection offers a complete bathroom solution including a wide range of basins of different sizes and mounting options.

Thanks to GROHE rimless technology, all toilets of this range are effortless to clean. Every Bau Ceramic toilet is equipped with a soft closing and quickly released seat. When you choose this collection, you can be sure to have everything covered for your project business – at an attractive price.



39 420 000
Wall hung basin
65 cm



39 421 000
Wall hung basin
60 cm



39 440 000
Wall hung basin
55 cm



39 424 000
Handrinse basin
45 cm



39 422 000
Drop in basin
55 cm



39 423 000
Undercounter basin
55 cm



39 426 000
Semi pedestal for wash basins



39 425 000
Pedestal for wash basin

39 421 000
Wall hung basin
60 cm



39 427 000
Wall hung WC
wash down



39 428 000
Floorstanding WC close coupled,
wash down, horizontal outlet



39 429 000
Floorstanding WC close coupled,
wash down, vertical outlet



39 436 000
Cistern with bottom inlet

39 437 000
Cistern with side and back inlet



39 430 000
Floorstanding WC, wash down,
horizontal outlet



39 431 000
Floorstanding WC, wash down,
vertical outlet



39 432 000
Floorstanding bidet



39 433 000
Wall hung bidet



39 438 000
Urinal concealed inlet

39 439 000
Urinal top inlet



39 434 000
WC seat

39 435 000
Seat & cover soft close

02

EURO CERAMIC

39 330 000
Seat & cover soft close

39 328 000
Wall hung WC

39 323 000
Wall hung basin
65 cm

39 201 000
Semi pedestal
for wash basins

EURO CERAMIC

IN TUNE WITH MY LIFESTYLE

Imagine a great looking bathroom which adapts effortlessly to your real life, where you start and end your day in a personal space. A bathroom which is both hugely practical but also fun and visually distinctive.

The Euro Ceramic range has been specially designed to match up an excellent performance with an attractive price. You can enjoy a flexible and stylish bathroom day in, day out for years to come.

- Unique combination of hygiene coating with ProGuard and HyperClean – optional
- All toilets have triple vortex flush (except floorstanding WC)
- All toilets are rimless



TRIPLE VORTEX FLUSH



RIMLESS TECHNOLOGY



PROGUARD



HYPERCLEAN



39 330 000
Seat & cover soft close

39 328 000
Wall hung WC



39 338 000
Floorstanding WC close coupled
in combination with cistern 30 332 000



39 323 000
Wall hung basin 65 cm



39 337 000
Countertop basin
60 cm



Discreet style to inspire. Good design doesn't need to shout. The flowing lines of Euro Ceramic effortlessly create a relaxing bathroom.



39 323 000
Wall hung basin
65 cm

EURO CERAMIC COLLECTION

Open up your bathroom to create a calming retreat that fosters thought, relaxation and well-being: with the Euro Ceramic range. This collection offers everything you need for bathroom solutions, especially small ones. All basins and toilets of this collection have a compact size and design to use space most effectively. Innovative technologies such as ProGuard and HyperClean are available for this range.



39 323 000
39 323 00H*
Wall hung basin
65 cm



39 336 000
39 336 00H*
Wall hung basin
55 cm



39 337 000
39 337 00H*
Countertop basin
60 cm



39 324 000
39 324 00H*
Handrinse basin
45 cm



39 327 000
39 327 00H*
Mini handrinse basin
37 cm



39 423 000
Undercounter basin
55 cm



39 201 000
Semi pedestal for wash basins



39 325 000
Semi pedestal for handrinse basin 45 cm



39 202 000
Pedestal for wash basin

* With hygiene coating

39 335 000
39 335 00H*
 Wall hung basin
 60 cm



39 206 000
39 206 00H*
 Compact wall hung
 WC, wash down



39 338 000
39 338 00H*
 Floorstanding WC, close coupled,
 wash down, universal



39 329 000
39 329 00H*
 Floorstanding WC, wash down,
 universal outlet



39 339 000
39 339 00H*
 Floorstanding WC, back to wall,
 wash down, universal outlet



39 332 000
 Cistern with bottom inlet



39 340 000
39 340 00H*
 Floorstanding bidet

39 333 000
 Cistern with side and back inlet outlet

39 328 000
39 328 00H*
 Wall hung WC
 wash down



39 208 000
39 208 00H*
 Wall hung bidet



39 330 000
 Seat & cover soft close

39 331 000
 Seat & cover w/o soft close

39 458 000
 Seat & cover soft close for compact toilet

39 459 000
 Seat & cover w/o soft close for compact toilet

* With hygiene coating

03

CUBE CERAMIC



39 477 00H
Countertop basin 60 cm

CUBE CERAMIC

A CLEAR STYLE STATEMENT

Step away from a busy, cosmopolitan life for a moment and enjoy the essentials. With its strong, minimalist lines, the stunning Cube Ceramic collection sums up cool and contemporary bathroom luxury. Every product in the collection has a sophisticated feel, modelled on the crisp, clean lines of the cube. The dynamic shapes and smooth surfaces are designed to be fuss-free, ideal for creating a modern bathroom scheme that brings a sense of calm clarity to your day.

- Hygiene coating with leading-edge surface technologies AquaCeramic and HyperClean
- Toilet range offers rimless and triple vortex technologies



TRIPLE VORTEX FLUSH



RIMLESS TECHNOLOGY



HYPERCLEAN



AQUACERAMIC



39 477 00H
Countertop basin 60 cm



39 244 00H
Wall hung WC



39 477 00H
Countertop basin, 60 cm



39 478 00H
Countertop basin, 50 cm



39 402 00H
Vessel basin 40 cm

Be inspired by the timeless quality of architectural design. The Cube Ceramic range of basin designs has been created to suit your personal style and routine, but all are united by crisp profiles and clean corners for an effortlessly contemporary look.



39 479 00H
Countertop built-in basin, 60 cm

CUBE CERAMIC COLLECTION

With ceramics from the Cube Ceramic range, you create a bathroom scheme that makes the best out of effortless chic and contemporary design. Generously proportioned, its distinctive basins turn your bathroom into a welcoming urban oasis. Take a time-off from the hectic world outside and let the shapes of the city inspire you.



39 437 00H
Wall hung basin
100 cm



39 469 00H
Wall hung basin
80 cm



39 474 00H
Wall hung basin
50 cm



39 475 00H
Countertop basin
100 cm



39 476 00H
Countertop basin
80 cm



39 477 00H
Countertop basin
60 cm



39 478 00H
Countertop basin
50 cm



39 479 00H
Drop-in basin
60 cm



39 480 00H
Undercounter basin
50 cm



39 437 00H
Wall hung basin
60 cm



39 481 00H
Vessel basin
50 cm



39 482 00H
Vessel basin
40 cm



39 483 00H
Handrinse basin
45 cm



39 484 00H
Floorstanding WC close coupled,
wash down, universal outlet

39 484 00H
Cistern with bottom inlet

39 489 00H
Cistern with side inlet



39 485 00H
Floorstanding WC back to wall,
wash down



39 244 00H
Wall hung WC
wash down



39 487 00H
Floorstanding bidet









39 487 00H
Wall hung bidet



39 487 00H
Seat & cover soft close

OVERVIEW OF ALL THREE LINES

	 AQUACERAMIC DOUBLE THE PROTECTION FROM IMPURITIES	 HYPERCLEAN NO CHANCE FOR BACTERIA TO GROW	 PROGUARD TOO SMOOTH FOR DIRT TO STICK TO	 TRIPLE VORTEX FLUSH THE POWER OF THREE: CLEAN AND SILENT	 RIMLESS TECHNOLOGY LEAVES BACTERIA NOWHERE TO HIDE	 SOFT CLOSE SEAT GENTLE AND QUIET	 QUICK RELEASE SEAT EASY REMOVAL FOR EASY CLEANING
BAU CERAMIC VERSATILITY FOR A MODERN LIFE					●	○	●
EURO CERAMIC IN TUNE WITH MY LIFESTYLE		○	○	●	●	○	●
CUBE CERAMIC A CLEAR STYLE STATEMENT	●*	●	●*	●	●	●	●
	Hydrophilic layer prevents residues sticking to the bowl Nano-technology prevents limescale latching onto the surface and attracting dirt A special application process ensures that the ceramic surface stays clean for a lifetime * for WC range	Exceptionally smooth, hardwearing finish prevents 99.9% of bacteria growth Natural anti-bacterial silver ions inhibit germs and prevent stains Ceramic stays sparklingly clean and germ-free with the minimum of effort Certified by the Society of Industrial Technology for Antimicrobial Articles	Prevents limescale maintaining the sparkling fresh from the box finish The smooth surface locks out dirt resulting from limescale for good * for wash basins	Three water outlets in the bowl create a powerful vortex effect that leaves nothing behind Every corner of the bowl is covered and cleaned Very quiet flush Less risk of splashing	No corners or crevices, which are playgrounds for bacteria	Both seat and lid have a gentle and quiet soft-closing mechanism	A special hinge allows easy removal of the toilet seat for cleaning

○ = optional

● = as standard

WITH OUR PERFECT MATCHES YOU CAN BE SURE THAT EVERYTHING FITS

A consistent design language and ergonomic use are essential for making your bathroom a place of true relaxation. With our perfect matches, we created three coordinated collections for a complete bathroom solution.

Each of our matches was tested to be perfect in design and function. Choose for yourself the line that most perfectly complements your personal style. Do you prefer the versatility of Bau Ceramic, the soft lines of Euro Ceramic or the modern and geometric shapes of Cube Ceramic?



OUR RECOMMENDATIONS



BAU CERAMIC



EURO CERAMIC



CUBE CERAMIC

FAUCETS



BAUEDGE
23 328 000

BAULOOP
23 335 000



EUROSMART
33 265 002

EUROSMART COSMOPOLITAN
32 082 500E

EUROSTYLE
33 558 003

EUROSTYLE COSMOPOLITAN
23 039 002

EUROCUBE
23 390 00E

LINEARE
32 114 001

ALLURE
32 757 000

ALLURE BRILLIANT
23 029 000

FLUSH PLATES



NOVA COSMOPOLITAN
38 765 000



ARENA COSMOPOLITAN
38 844 000



SKATE COSMOPOLITAN
37 535 000

ACCESSORIES



BAU COSMOPOLITAN TOWEL RING
40 460 001



ESSENTIALS TOWEL RING
40 365 001



SELECTION CUBE TOWEL RING
40 766 000

TECHNICAL DRAWINGS

To help you plan your bathroom down to the last detail, here are the important dimensions of the Bau Ceramic and Euro Ceramic lines.



BAU CERAMIC VERSATILITY FOR A MODERN LIFE

WASHBASIN

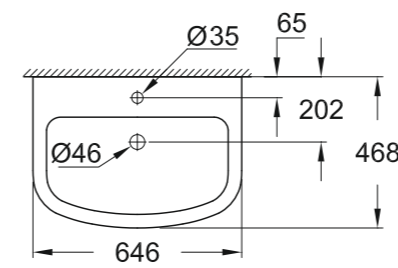

39 420 000
Wall hung basin
65 cm

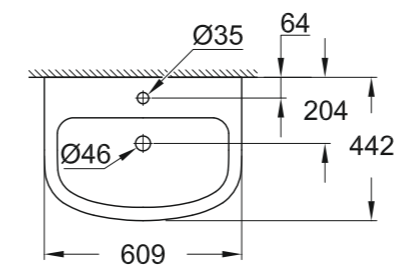
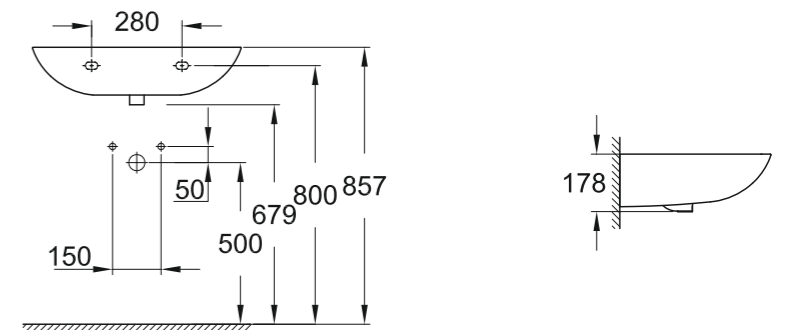

39 421 000
Wall hung basin
60 cm

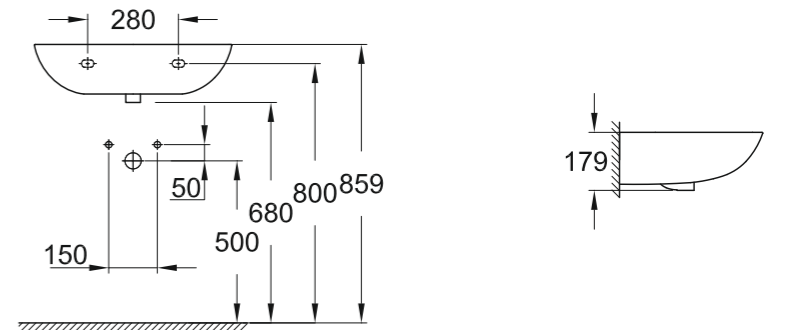

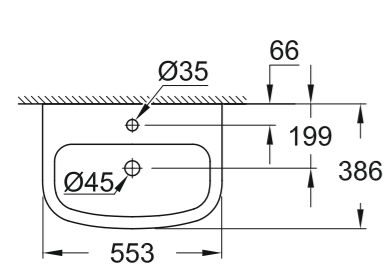

39 440 000
Wall hung basin
55 cm

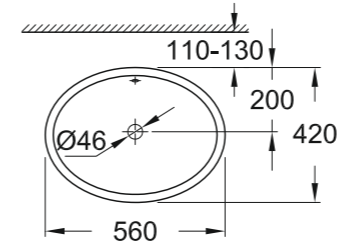
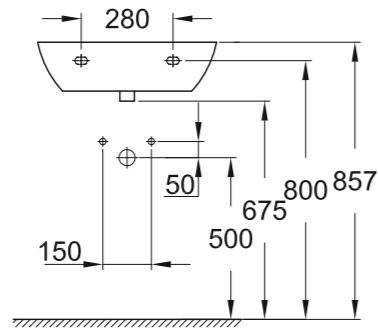

39 423 000
Undercounter basin
55 cm

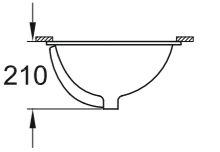
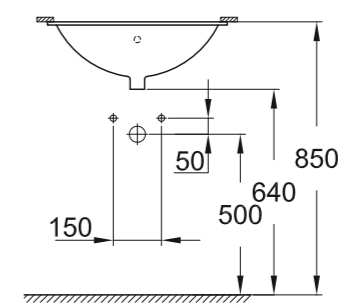

PEDESTAL

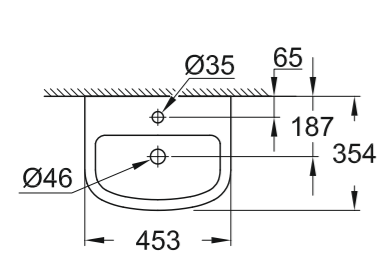

39 424 000
Handrinse basin
45 cm

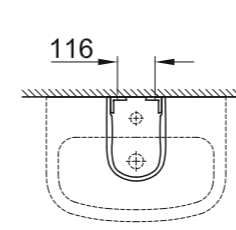
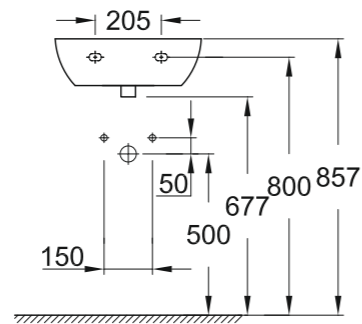

39 426 000
Semi pedestal for wash basins

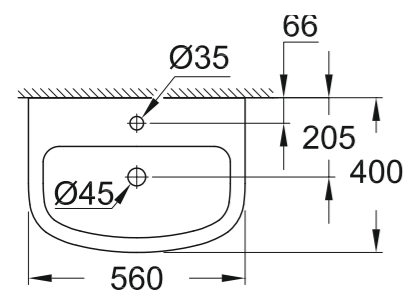
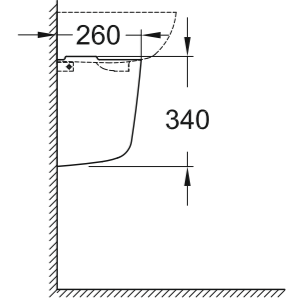
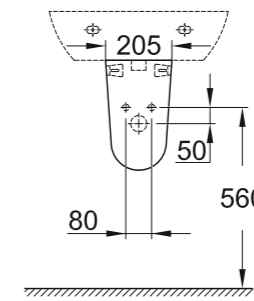

39 422 000
Drop in basin
55 cm

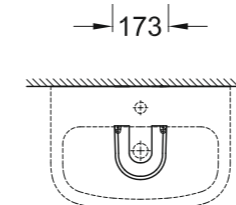
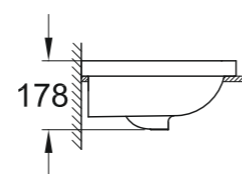
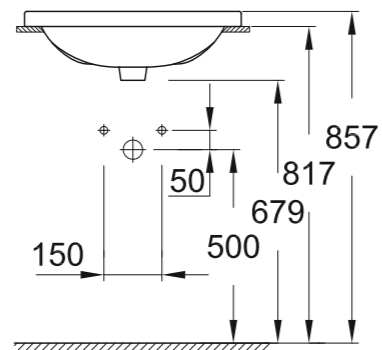

39 425 000
Pedestal for wash basin

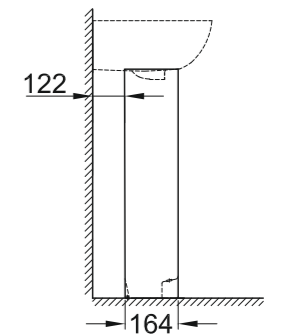
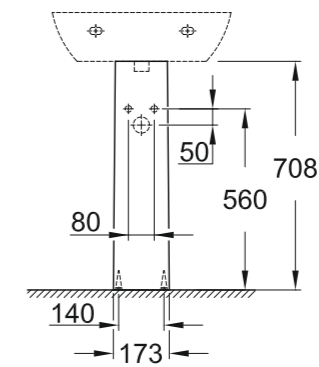

WC/CISTERN

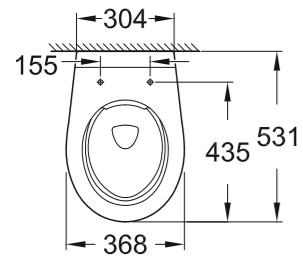

39 427 000
Wall hung WC,
wash down

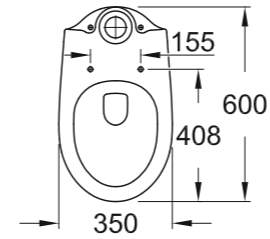
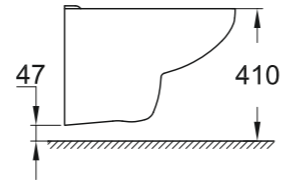
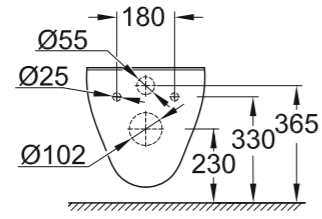

39 428 000
Floorstanding WC close coupled,
wash down, horizontal outlet

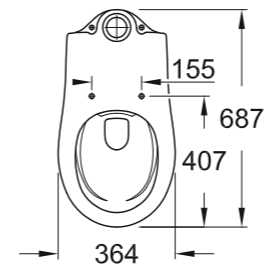
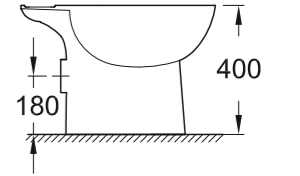
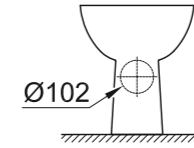

39 429 000
Floorstanding WC close coupled,
wash down, vertical outlet

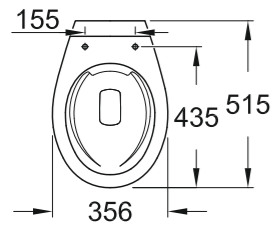
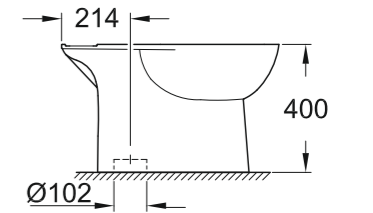
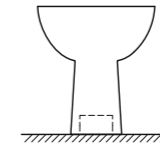

39 430 000
Floorstanding WC, wash down,
horizontal outlet

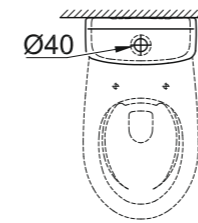
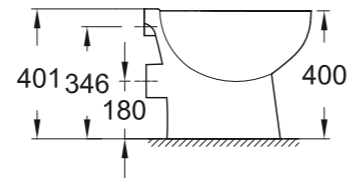
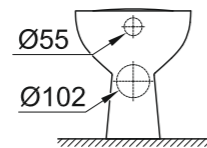

39 436 000
Cistern with bottom inlet

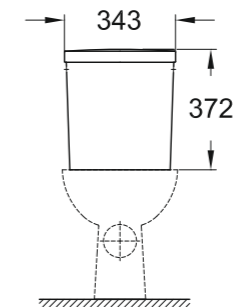

39 437 000
Cistern with side and back inlet

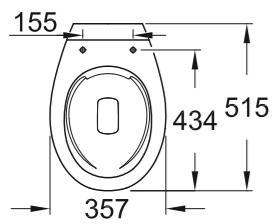
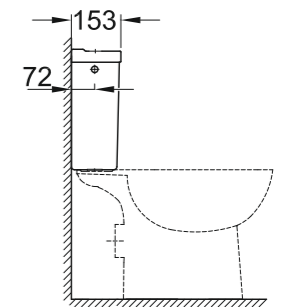

39 431 000
Floorstanding WC, wash down,
vertical outlet

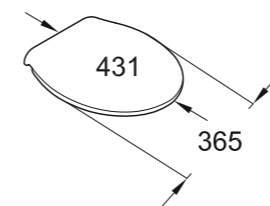
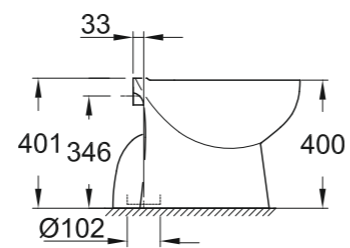
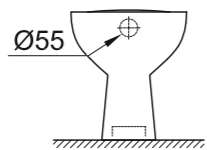

39 429 000
Floorstanding WC close coupled,
wash down, vertical outlet

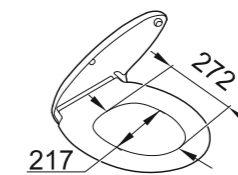

BIDET/URINAL

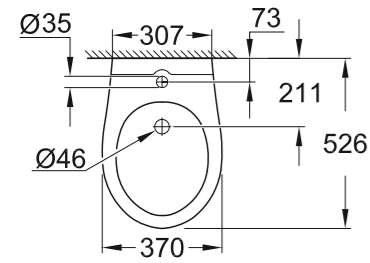

39 433 000
Wall hung bidet

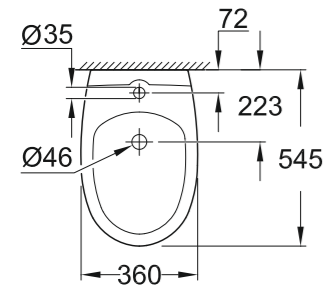
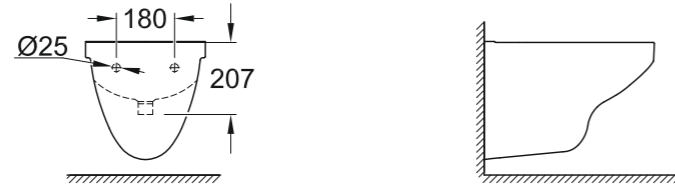

39 432 000
Floorstanding bidet

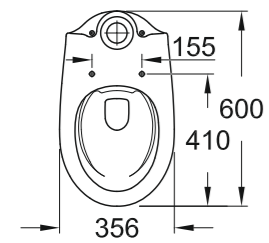

39 438 000
Urinal concealed inlet

39 439 000
Urinal top inlet

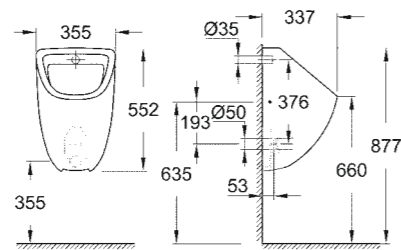

EURO CERAMIC
IN TUNE WITH MY LIFESTYLE

WASHBASIN/PEDESTAL

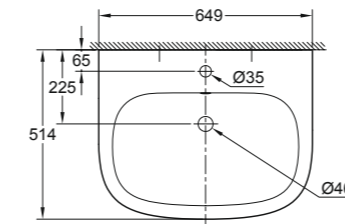

39 323 000
39 323 00H*
Wall hung basin
65 cm

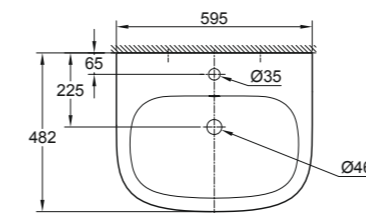
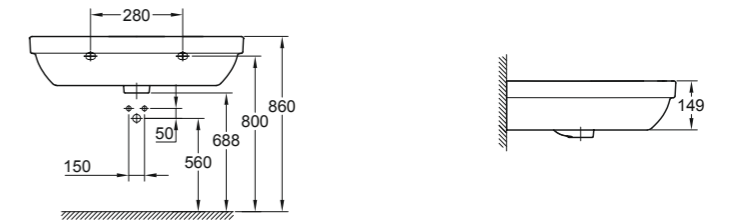

39 335 000
39 335 00H*
Wall hung basin
60 cm

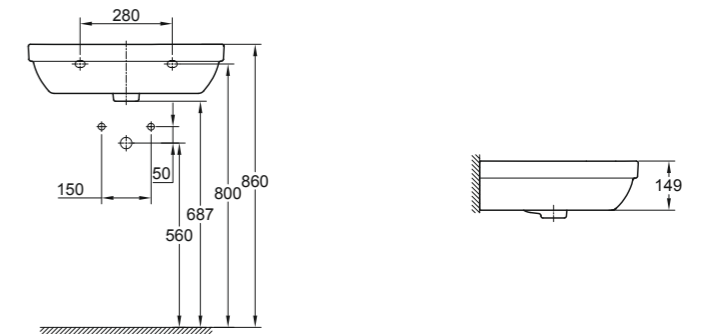

* With hygiene coating

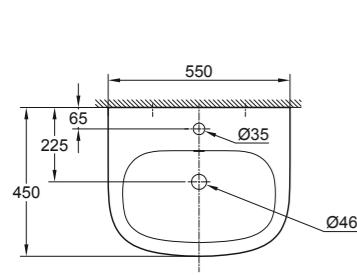

39 336 000
39 336 00H*
 Wall hung basin
 55 cm

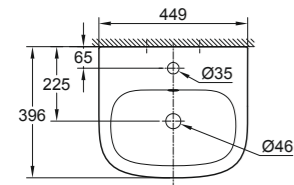
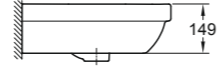
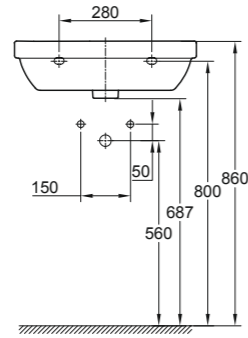

39 324 000
39 324 00H*
 Handrinse basin
 45 cm

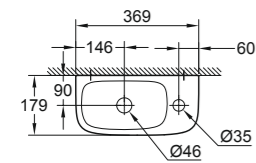
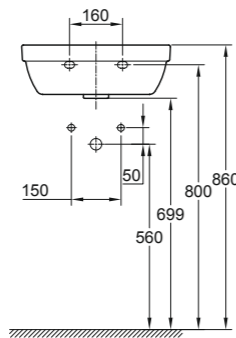

39 327 000
39 327 00H*
 Mini handrinse basin
 37 cm

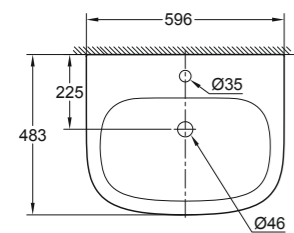
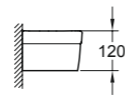
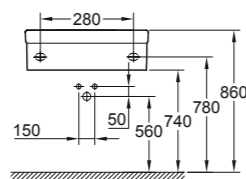

39 337 000
39 337 00H*
 Countertop basin
 60 cm

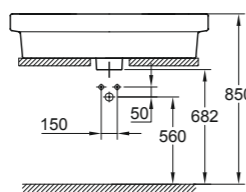

PEDESTAL

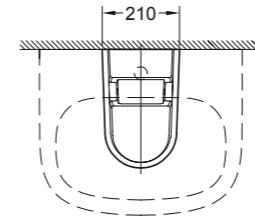

39 201 000
 Semi pedestal for wash basins

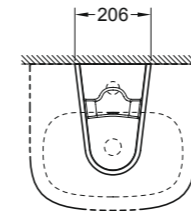
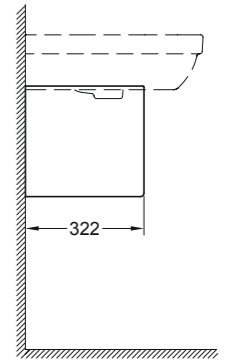
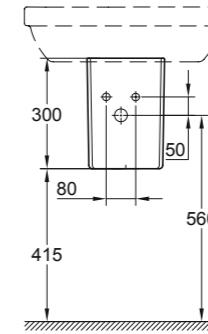

39 325 000
 Semi pedestal for handrinse basin 45 cm

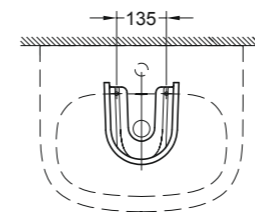
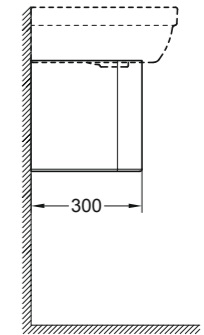
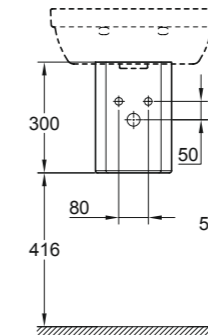

39 202 000
 Pedestal for wash basin

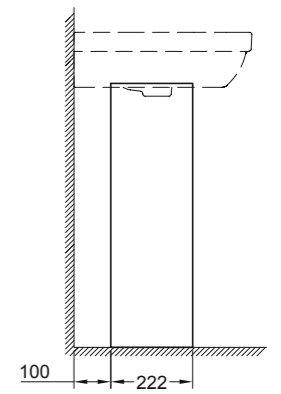
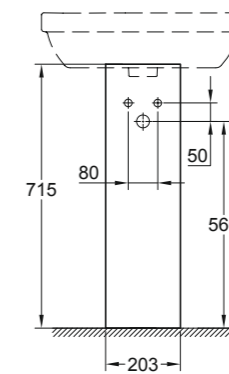

* With hygiene coating

WC/ BIDET

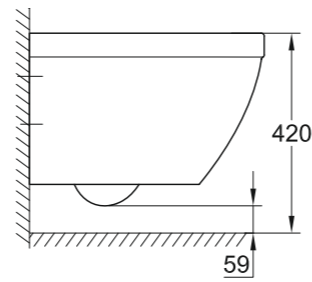
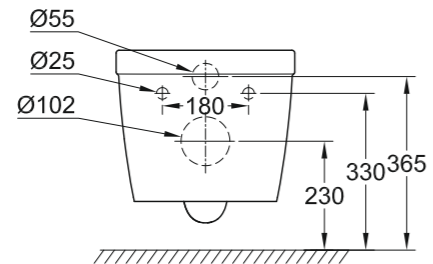
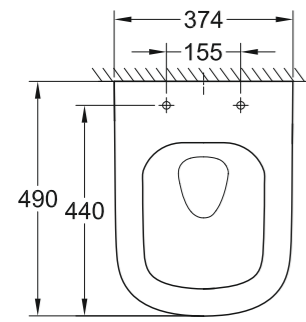

39 206 000
39 206 00H*
Compact wall hung
WC, wash down

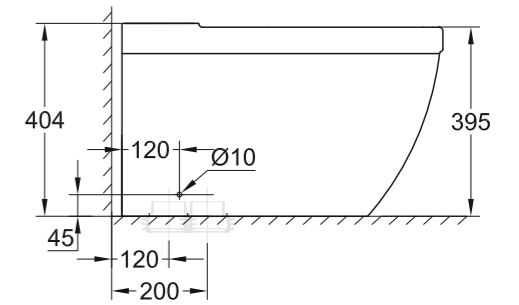
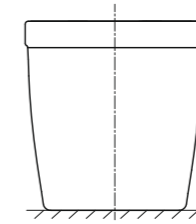
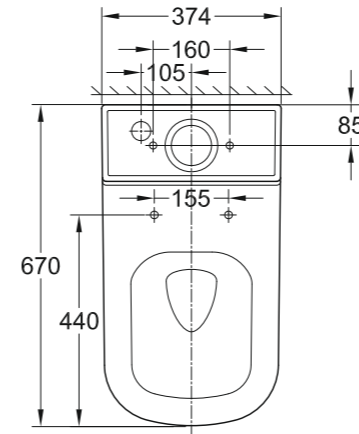

39 338 000
39 338 00H*
Floorstanding WC, close coupled, wash down, universal

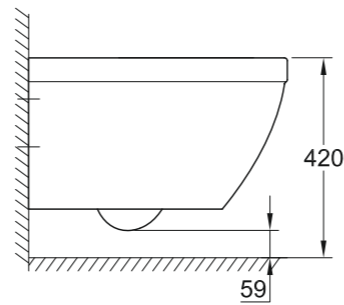
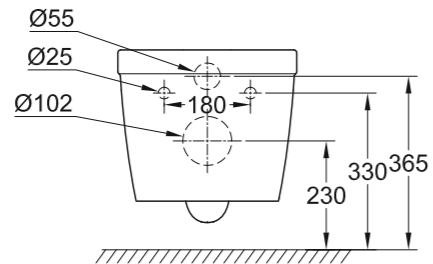
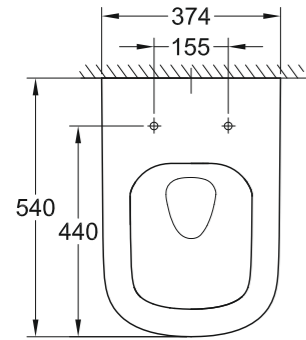

39 328 000
39 328 00H*
Wall hung WC,
wash down

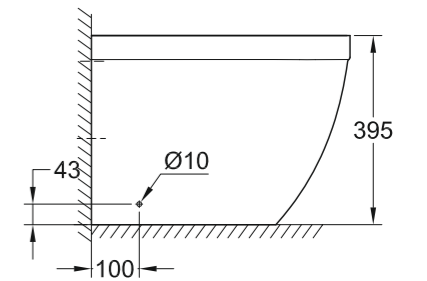
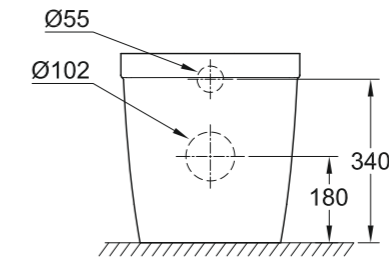
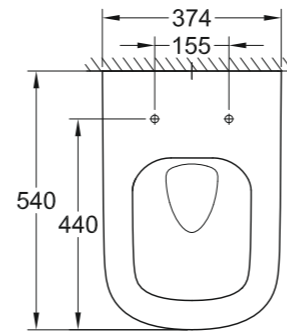

39 339 000
39 339 00H*
Floorstanding WC, back to wall, wash down, universal outlet

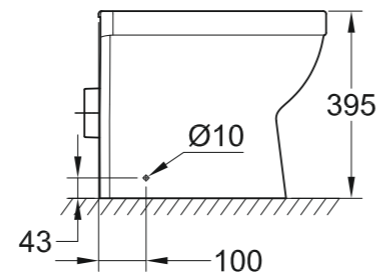
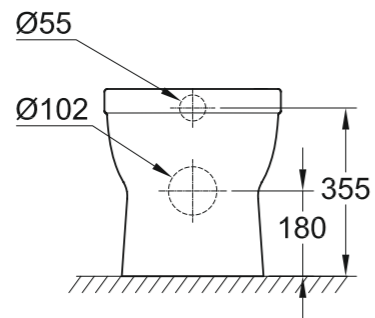
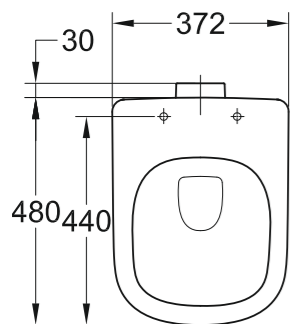

39 329 000
39 329 00H*
Floorstanding WC, wash down,
universal outlet

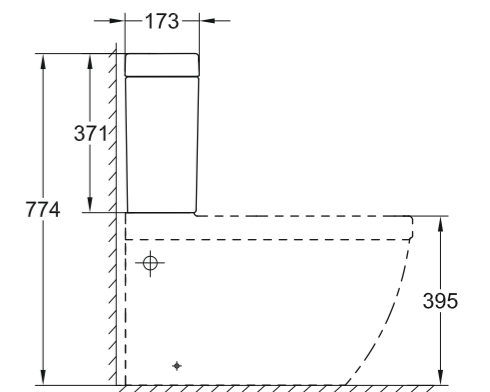
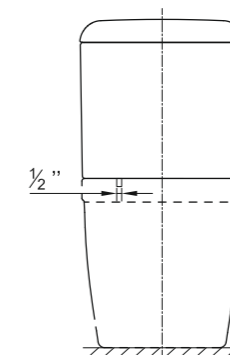
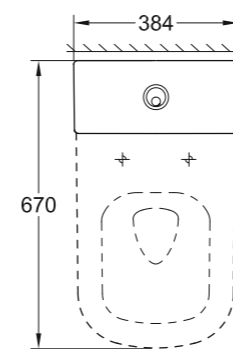

39 332 000
Cistern with bottom inlet

* With hygiene coating

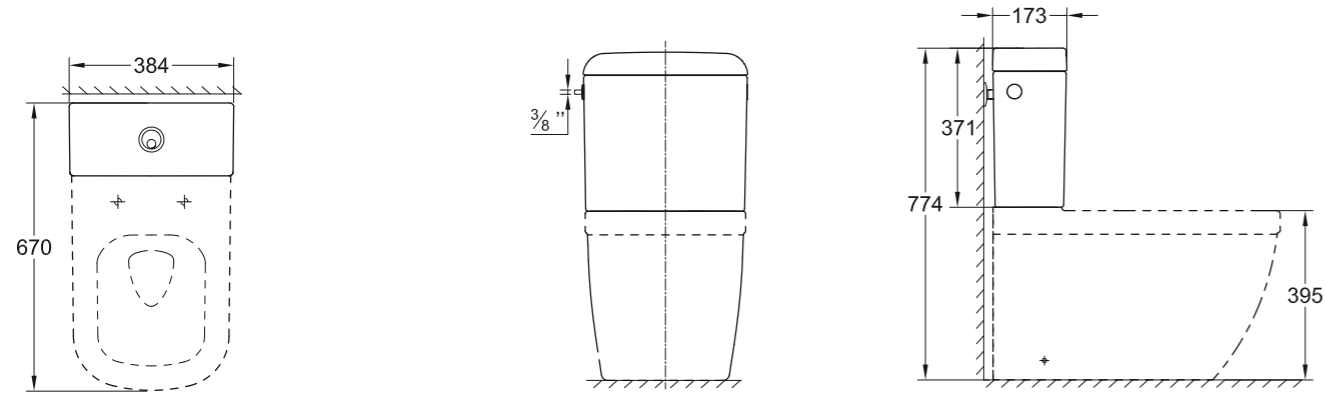

39 333 000
Cistern with side and back inlet outlet

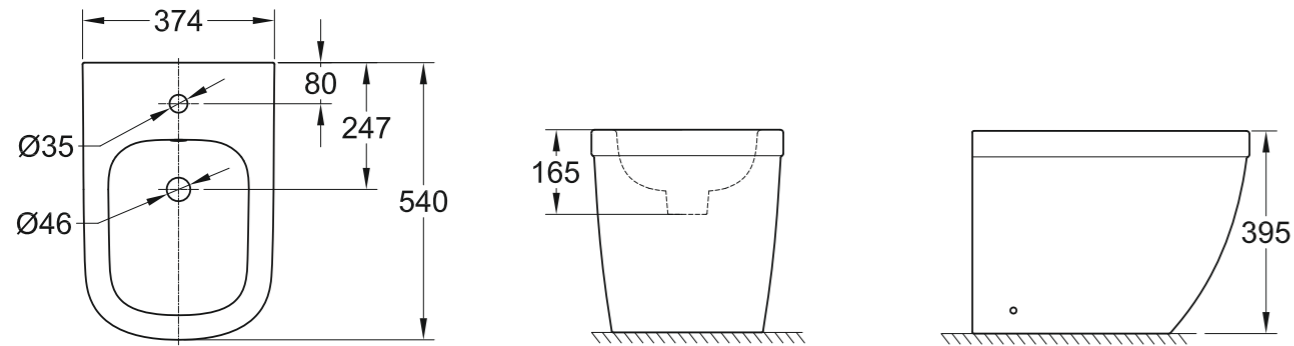

39 340 000
39 340 00H*
Floorstanding bidet

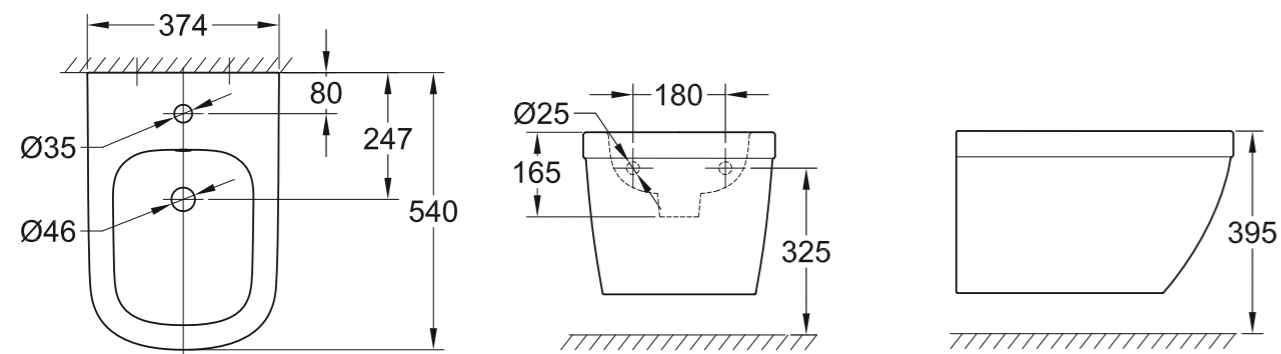

39 208 000
39 208 00H*
Wall hung bidet

SEAT

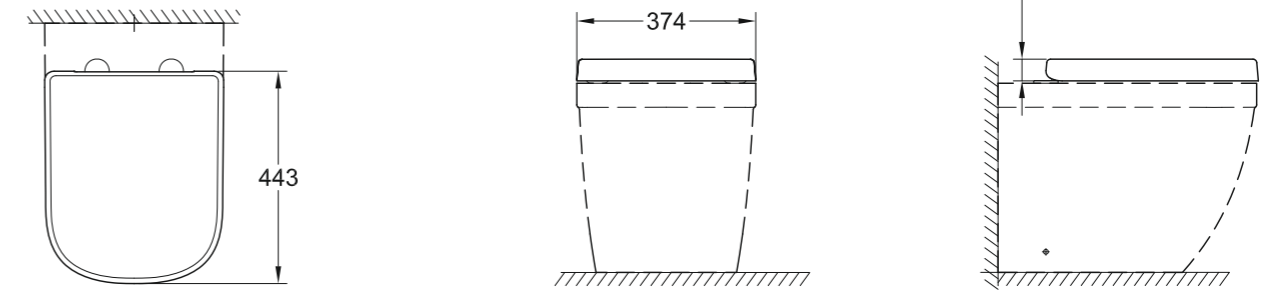

39 330 000
Seat & cover soft close

39 331 000
Seat & cover w/o soft close

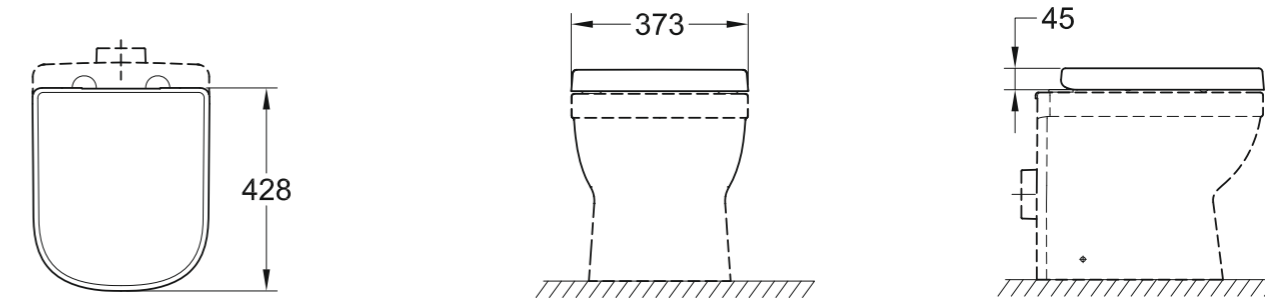

39 459 000
Seat & cover w/o soft close for compact toilet

39 458 000
Seat & cover soft close for compact toilet

* With hygiene coating

PURE FREUDE AN WASSER

Life-giving, universal, joyful – water itself is the source of inspiration for the whole of our distinctive product portfolio. Each of these products is always based on our four core values: Quality, Technology,

Design and Sustainability. Balancing these in everything we do, allows us to deliver unrivalled water enjoyment to our customers.

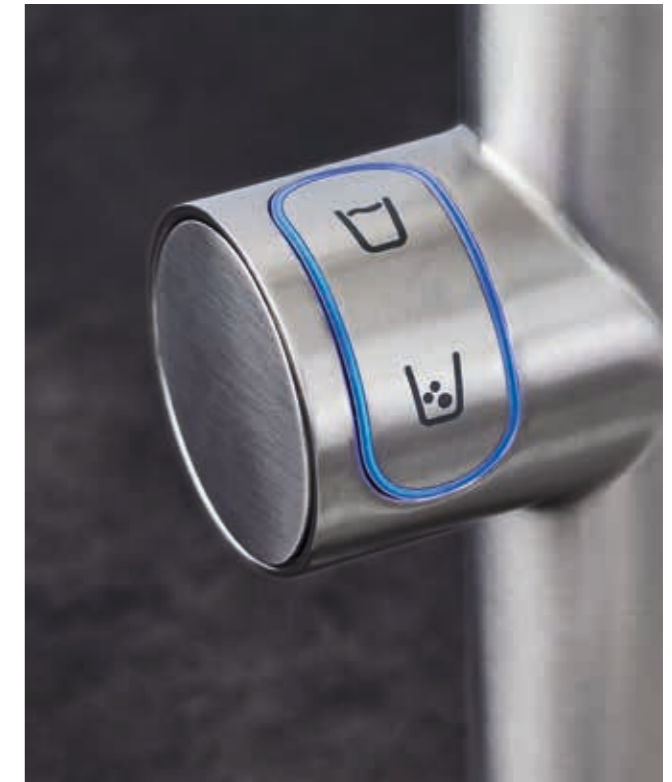

QUALITY

GERMAN PERFECTIONISM INSPIRES ULTIMATE CUSTOMER CONFIDENCE.

We strive for an excellence that goes way beyond the surface of our products. In fact, from design to production and customer service we aim for nothing less than perfection at every stage. Our history of great German engineering, rigorous internal tests and numerous external certification processes are what gives our customers complete confidence in a name they can trust.

TECHNOLOGY

MASTERING WATER THROUGH TECHNOLOGY.

In our relentless search for technological innovation we work to integrate the latest digital advances, creating smart solutions that enhance our customers' enjoyment of water. Our in-house experts harness the power of water to enhance the experience of our customers every day – the moment of truth, for our products and brand.

DESIGN

SIGNATURE ELEMENTS STYLED TO PERFECTION.

An empathetic and intuitive design language offers us the opportunity to create products that feel as if they were designed just for you. This unique GROHE DNA that is both ergonomic and visually distinctive has earned us numerous design awards: world class references are testimony to our world-wide recognition.

SUSTAINABILITY

ENSURING WATER ENJOYMENT FOR GENERATIONS TO COME.

Water is as essential as the air that we breathe, one more reason why we are so passionate about it. To be able to offer "Pure Freude an Wasser", not just to today's consumer but for generations to come, we offer sustainable product solutions like GROHE Blue, GROHE EcoJoy and GROHE SilkMove ES, and we demonstrate through our Sustainability Report and Sustainability accolades that we have made a serious corporate commitment to protecting the planet.

DISCOVER THE WORLD OF GROHE

What you see here represents just a small selection of what the world of GROHE has to offer. Whether you are looking for ideas and inspiration or solutions for bath and kitchen, here's where you'll find it.

Just scan the QR codes to view the latest brochures as download or PDF on your tablet or smart phone.

OR VISIT THE WORLD OF GROHE AT GROHE.COM

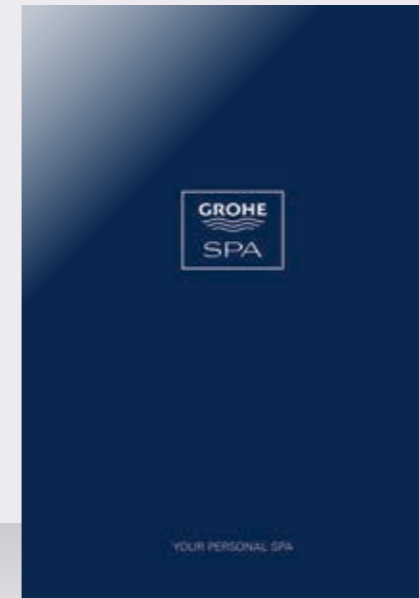

SPA BROCHURE



SENSIA ARENA BROCHURE



WATER. INTELLIGENCE. ENJOYMENT. MAGAZIN

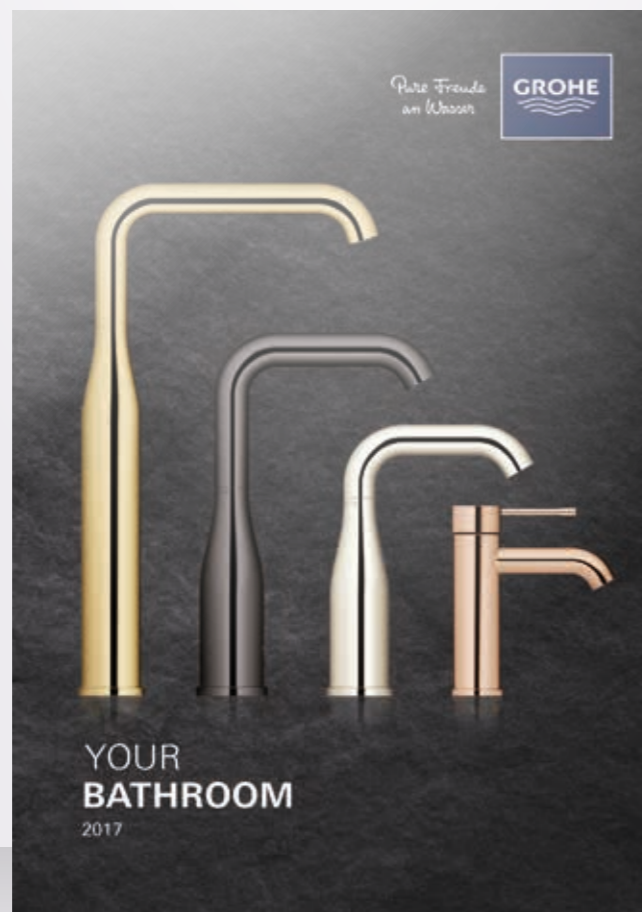

BATH BROCHURE

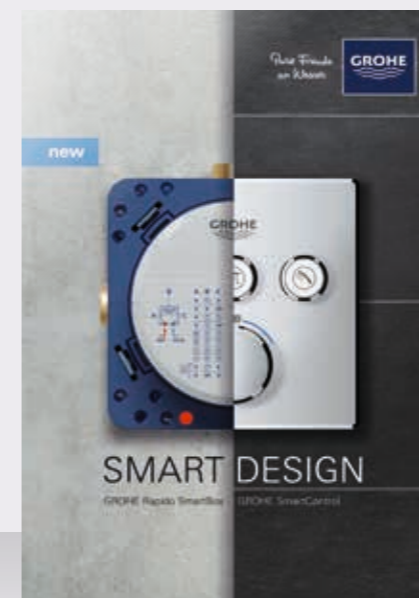

RAPIDO SMARTBOX BROCHURE



KITCHEN BROCHURE



SANITARY SYSTEMS BROCHURE

